



Geräteinformation
Appliance information

Der Druckmelder schützt Silos und Behälter vor zu hohem Überdruck bei der pneumatischen Befüllung.

The silo pressure detector is protecting silos and containers from too high pressure during the pneumatic filling process.

Abmessungen / Dimensions

Kunststoff-Gehäuse
Plastic-housing

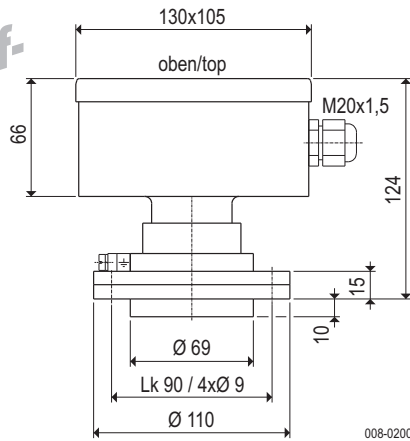

008-0200

Dichtring / seal ring

Zubehör / Supplies
Flanschstützen / protruding nozzle

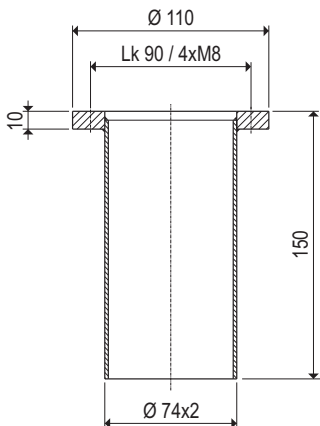

ATEX-Option
ATEX-Option

Anschlussplan
Connection plan

Staub Dust
Ex II 1/3D IP65 T 83 °C

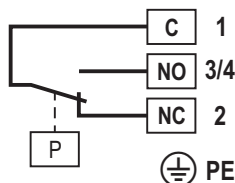

008-AP00

Funktionsweise

Nutzung eines Druckanstieges im Silo oder Behälter.
Steigt der Druck auf die Membrane, dann registriert ein Signalschalter diesen Druckanstieg und wertet ihn aus.

Mode of operating

Using the increasing pressure in the silo or container.
Increases the pressure to the membrane, the signal switch registers the pressure difference and evaluates it.

Einsatz

Der Silo-Druckmelder dient als Grenzwertgeber zur Überwachung des Überdruckes in Silos und Behälter, die mit einer pneumatischen Förderanlage befüllt werden.
Erreicht der Druck den Schalterpunkt, dann gibt der Melder ein Signal.

Use

The silo pressure detector is used as limit switch to control the pressure in silos and containers, being filled by a pneumatic conveyer system.
If the pressure is reaching the switching point, the pressure detector will give a signal.

Technische Daten / Technical data

Werkstoffe	Gehäuse Flansch Membrane Flanschstützen	ABS, grau Aluminium 1.4301 Normalstahl
Materials	housing flange membrane protruding nozzle	ABS, grey (high impact plastic) aluminium stainless steel steel
Schüttguttemperatur Bulk temperature		-25 °C ... +80 °C T_s -25 °C ... +80 °C
Umgebungstemperatur Ambient temperature		-20 °C ... +70 °C T_a -20 °C ... +70 °C
Signal-Kontakt Schaltvermögen Schaltspannung		potenzialfreier Wechsler 4 A / 250 V AC 24 V ... 250 V AC oder 12 V ... 125 V DC Contact
Signal contact Capacity of the contact Switching voltage		change-over contact, potentialfree 4 A / 250 V AC 24 V ... 250 V AC or 12 V ... 125 V DC
Schalterpunkt Switching point	SP	40 mbar = 0,04 bar = 400 mm WS 40 mbar = 0,04 bar = 400 mm WS
Überdrucksicherheit Overpressure safety		bis 0,5 bar up to 0,5 bar
Kabeleinführung Cable entry		Verschraubung M20x1,5 Gland M20x1,5
Schutzart Type of protection	IP	IP65 nach DIN EN 60529 IP65 acc. to DIN EN 60529
Gewicht / Weight		1,1 kg
Wartung / Maintenance		keine / none
Einbaulage / Mounting position		senkrecht / vertical
Bestellcode / Order code		2230 2230-A-001 (ATEX Option)

► Read and follow these safety instructions first and take notice of the operating instructions.

Safety instructions

1. The installation, initial operation and maintenance may be done by a qualified expert with electrical know-how only.
2. Take notice of the local and statutory rules and regulations while the electrical connection and/or the VDE 0100.
3. Take notice of the characteristics at the data plate.
4. A fuse (with max. 4A) has to be connected in series to the voltage supply.
5. Protect the signal contact from voltage peaks when inductive loads are connected.
6. The device may put into operation if it is closed, only.
7. Switch off the power supply, before opening the device. (touchdangerous voltage)
8. Attention safety device! Don't modify anything at the device or at the switching point adjusting!

Operating instructions

1. Description

1.1 Intended use

The silo pressure detector controls as limit switch the overpressure in silos and containers.

1.2 Function

If the pressure reaches the switching point **SP**, the pressure detector will give a signal.

1.3 Technical data

Manufacturer	Talleres Filsa, S.A.U.
Address	Bernat Metge, 33 08100 Mollet del Vallés (Barcelona-Spain)
Name	Silo pressure detector
Type	KP
Bulk good temperature	T_s -25 °C ... +80 °C
Ambient temperature	T_a -20 °C ... +70 °C
Signal contact	change-over contact, potentialfree
Capacity of the contact	Contact 4 A / 250 V AC
Switching voltage	24 V ... 250 V AC or 12 V ... 125 V DC
Switching point	SP 40 mbar = 0.04 bar = 400 mm WS
Overpressure safety	up to 0.5 bar
Cable entry	cable gland M20x1.5
Type of protection	IP IP 65 acc. to DIN EN 60529
Weight	1.1 kg
Maintenance	none
Mounting position	vertical, ± 5° inclination

1.4 Material

Housing	ABS (high impact plastic), grey
Flange	aluminium
	as option stainless steel
Membrane	stainless steel
Flange socket	steel

1.5 Dimensions

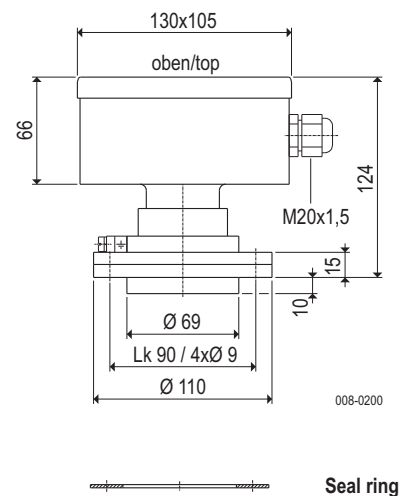

1.6 Accessory (option) Flange socket

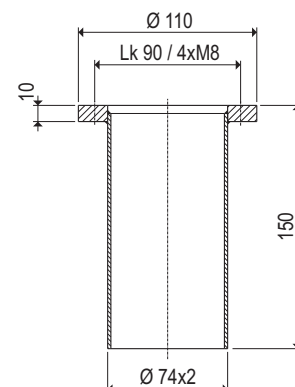

2. Installation

2.1 Preparation

- Read and follow the safety instructions and the operating instructions before mounting the device!

2.2 Mechanical connections

- Weld the flange socket (as a option) in the silo top.
- Put the pressure detector with the sealing in a vertical position (flange is horizontal) at the flange or at the flange socket and screw it with screws M8 and washers.

2.3 Electrical connection

connection plan

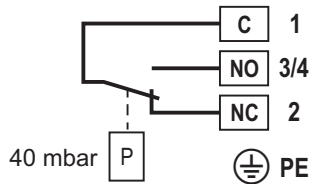

008-AP00

2.4 Cable gland

After the electrical connection

- the cable gland has to be screwed tightly,
- the cap nut has to be screwed until the cable gland is fixed and closed tightly.

2.5 Cable run

- Run the connection cable in a way that no traction can occur at the silo pressure detector.

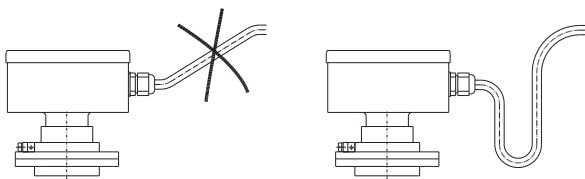

008-0700

2.6 Switching point

- The switching point is adjusted at 40 mbar.
- A modification of the switching point may be carried out by the manufacturer only.

3. Utilization

3.1 Putting into operation

- Put the silo pressure detector into operation only, when the mounting in the container or silo has been done correctly and if it has been fixed tightly with the electrical connection.

3.2 Normal operation

- Use the silo pressure detector in its intended application only.
- Comply with the details about maximum temperatures, stated on the data plate.
- If the silo pressure detector will be damaged, take the device out of operation immediately.
- The silo pressure detector must not be modified. If there is any modification, the warranty of the manufacturer will be cancelled.

3.3 Inexpert handling

- Ignoring of the safety instructions and the operating instructions.
- Utilization of the silo pressure detector in not intended use.
- Modification at the pressure detector or of the switching point adjusting.
- Violation against applicable law and standards.

4. Maintenance and servicing

4.1 Maintenance

- In case of intended use, the silo pressure detector needs no maintenance.

4.2 Servicing

- The servicing of the silo pressure detector may be carried out by the manufacturer only.

5. Storage

- While storage the silo pressure detector has to be protected from dust and humidity.
- Protect the membrane from damage.

6. Disposal

- The silo pressure detector can be recycled.
- The disposal applies to the valid environmental guidelines according to the location of the carrier and the local manufacturing conditions.